

Multichannel Media Converter

33214.A

METTF10xx, MFETF10xx

COMPLIANCE INFORMATION

UL Listed

C-UL Listed (Canada)

CISPR/EN55022 Class A

FCC Regulations

This equipment has been tested and found to comply with the limits for a class A digital device, pursuant to part 15 of the FCC rules. These limits are designed to provide reasonable protection against harmful interference when the equipment is operated in a commercial environment. This equipment generates, uses, and can radiate radio frequency energy and, if not installed and used in accordance with the instruction manual, may cause harmful interference to radio communications. Operation of this equipment in a residential area is likely to cause harmful interference, in which case the user will be required to correct the interference at the user's own expense.

Canadian Regulations

This digital apparatus does not exceed the Class A limits for radio noise for digital apparatus set out on the radio interference regulations of the Canadian Department of Communications.

Le présent appareil numérique n'émet pas de bruits radioélectriques dépassant les limites applicables aux appareils numériques de la class A prescrites dans le Règlement sur le brouillage radioélectrique édicté par le ministère des Communications du Canada.

European Regulations

Warning

This is a Class A product. In a domestic environment this product may cause radio interference in which case the user may be required to take adequate measures.

Achtung !

Dieses ist ein Gerät der Funkstörgrenzwertklasse A. In Wohnbereichen können bei Betrieb dieses Gerätes Rundfunkstörungen auftreten, in welchen Fällen der Benutzer für entsprechende Gegenmaßnahmen verantwortlich ist.

Attention !

Ceci est un produit de Classe A. Dans un environnement domestique, ce produit risque de créer des interférences radioélectriques, il appartiendra alors à l'utilisateur de prendre les mesures spécifiques appropriées

VCCI Class 1 Compliance

This equipment is in the 1st Class category (information equipment to be used in commercial and/or industrial areas) and conforms to the standards set by the Voluntary Control Council For Interference by Data Processing Equipment and Electronic Office Machines aimed at preventing radio interference in commercial and/or industrial areas. When used in a residential area or in an adjacent area thereto, interference may be caused to radio and TV receivers, etc. Read the instructions for correct handling.

この装置は、第一種情報装置（商工業地域において使用されるべき情報装置）で商工業地域での電波障害防止を目的とした情報処理装置等電波障害自主規制協議会（VCCI）基準に適合しております。

従って、住宅地域またはその隣接した地域で使用すると、ラジオ、テレビジョン受信機等に受信障害を与えることがあります。

取扱説明書に従って正しい取り扱いをして下さい。

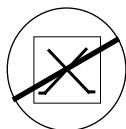

CAUTION: RJ CONNECTORS ARE NOT INTENDED FOR CONNECTION TO THE PUBLIC TELEPHONE NETWORK. Failure to observe this caution could result in damage to the public telephone network.

Der Anschluss dieses Gerätes an ein öffentliches Telekommunikationsnetz in den EG-Mitgliedstaaten verstößt gegen die jeweiligen einzelstaatlichen Gesetze zur Anwendung der Richtlinie 91/263/EWG zur

Angeleichung der Rechtsvorschriften der Mitgliedstaaten über Telekommunikationsendeinrichtungen einschliesslich der gegenseitigen Anerkennung ihrer Konformität.

Trademark Notice

All registered trademarks and trademarks are the property of their respective owners.

Copyright Restrictions

© 2001 TRANSITION Networks.

All rights reserved. No part of this work may be reproduced or used in any form or by any means – graphic, electronic, or mechanical – without written permission from TRANSITION Networks.

Printed in the U.S.A.

Table of Contents

1. INTRODUCTION	1.1
1.1 Multichannel Media Converter Models	1.2
1.2 Media Converter Channels	1.2
1.3 Channel Switches	1.3
1.4 Reset Button	1.3
1.5 AC Power Supply Module/Optional Redundant AC Power Supply Module	1.3
1.6 Multichannel Media Converter Management Module	1.4
1.7 Multiport Management Software at Remote NMS	1.5
2. INSTALLATION	2.1
2.1 Preparing the Site	2.2
2.2 Unpacking METTF10xx, MFETF10xx Equipment	2.3
2.3 Installing Optional Redundant Power Supply Module	2.4
2.3.1 Setting Management Module Jumper	2.4
2.3.2 Installing Power Supply Module	2.5
2.4 Installing Multichannel Media Converter at Site	2.6
2.4.1 Standard Rack Installation	2.6
2.4.2 Table-Top Installation	2.7
2.5 Powering the Multichannel Media Converter	2.8
2.6 Connecting Channel Ports to Network	2.9
2.6.1 Setting FDX/HDX Channel Configuration Switches	2.9
2.6.2 Installing Fiber-optic Cable	2.10
2.6.3 Installing Twisted-Pair Copper Cable	2.11
2.7 Setting Network Management Parameters	2.12
2.8 Connecting to TCP/IP Network Management at Remote Network Management Station (NMS)	2.14
2.9 Installing Multiport Management Software at Remote NMS	2.15

3. OPERATION	3.1
3.1 Using Status LEDs	3.2
3.2 Using a Terminal Emulator	3.3
3.3 Using Multiport Management Software at Remote NMS	3.6
4 MAINTENANCE	4.1
4.1 Fault Isolation and Recovery	4.2
4.2 Hardware Replacement Procedures	4.5
4.2.1 Replacing Management Module	4.5
4.2.2 Replacing AC Power Supply Module	4.6
APPENDIX	A.1
Appendix A. Technical Specifications	A.1
Appendix B. Cable Specifications	B.1

1. INTRODUCTION

The TRANSITION Networks METTF10xx (Ethernet™) and MFETF10xx (Fast Ethernet™) series Multichannel Media Converters connect twisted-pair copper cable to fiber-optic cable in separate copper-to-fiber media converter pairs, called channels. The network administrator can select a Multichannel Media Converter that provides up to six (6) or up to twelve (12) channels, with either 10BASE-T/10BASE-FL or 100BASE-TX/100BASE-FX connections and with either ST or SC fiber connectors.

The Multichannel Media Converter can be installed as a standalone unit or in a standard rack and can be managed at an attached terminal or using an SNMP application at a remote Network Management Station. Full-duplex or half-duplex network operation, *for each channel*, is switch-selectable or software-selectable.

1.1	<i>Multichannel Media Converter Models</i>	1.2
1.2	<i>Media Converter Channels</i>	1.2
1.3	<i>Channel Switches</i>	1.3
1.4	<i>AC Power Supply Module/Optional Redundant AC Power Supply Module</i>	1.3
1.5	<i>Multichannel Media Converter Management Module</i>	1.4
1.6	<i>Multipoint Management Software at Remote NMS</i>	1.5

1.1 Multichannel Media Converter Models

The TRANSITION Networks METTF10xx and MFETF10xx series Multichannel Media Converters can be selected according to network requirements:

MFETF1011-120 12-channel 100 Mb/s, multimode fiber, ST connectors

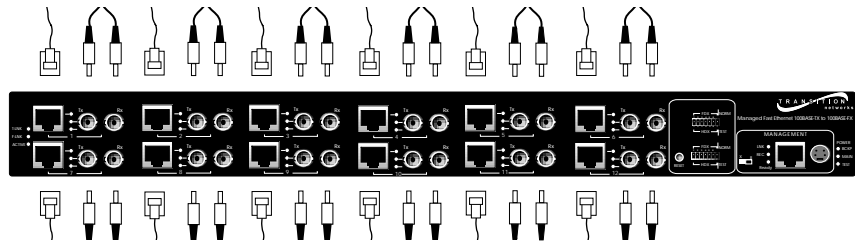

MFETF1013-120 12-channel 100 Mb/s, multimode fiber, SC connectors

MFETF1011-060 6-channel 100 Mb/s, multimode fiber, ST connectors

MFETF1013-060 6-channel 100 Mb/s, multimode fiber, SC connectors

METTF1011-120 12-channel 10 Mb/s, multimode fiber, ST connectors

METTF1013-120 12-channel 10 Mb/s, multimode fiber, SC connectors

METTF1011-060 6-channel 10 Mb/s, multimode fiber, ST connectors

METTF1013-060 6-channel 10 Mb/s, multimode fiber, SC connectors

1.2 Media Converter Channels

Channels connect twisted-pair copper cable to fiber-optic cable.

Twisted-Pair Ports IEEE802.3-compliant 10BASE-T/100BASE-TX twisted-pair ports operate at 10Mb/s or 100Mb/s, full-duplex or half-duplex.

Fiber-Optic Ports IEEE802.3-compliant 10BASE-FL/100BASE-FX fiber-optic ports operate at 10Mb/s or 100Mb/s, full-duplex or half-duplex.

Channel LEDs A set of LEDs monitor the status of EACH Media Converter channel.

T-LNK Steady LED indicates that twisted-pair link has been established between the channel and the twisted-pair node

F-LNK Steady LED indicates that fiber link has been established between the channel and the fiber node

ACTIVE Steady LED indicates that fiber port is receiving traffic.

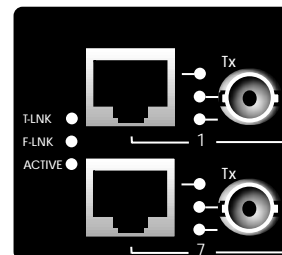

1.3 Channel Switches

Full-duplex/half-duplex mode selection switches (DIP switches #1-6) allow the network administrator to set EACH media converter channel, separately, either to full-duplex or to half-duplex.

The Link Test switch (DIP switch #7) enables or disables the Missing Link Test feature for a block of six (6) Multichannel Media Converter channels.

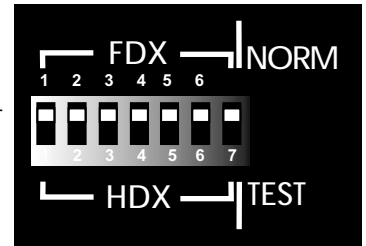

1.4 Reset Button

Located **only** on 100BASE-TX MFETF10xx series Multichannel Media Converter models, the Rest button, if present, allows the network administrator to reset ALL Multichannel Media Converter channel ports.

1.5 AC Power Supply Module/Optional Redundant AC Power Supply Module

An AC Power Supply Module, installed at the back of the Multichannel Media Converter before shipment, supplies power to the Multichannel Media Converter through an external power cord connected to an external AC outlet.

NOTE: The Multichannel Media Converter does not have an ON/OFF power switch. Power is applied to, and removed from, the Multichannel Media Converter by connecting and disconnecting the power cord.

The Multichannel Media Converter rear panel also contains an expansion slot for an optional redundant Power Supply Module. When installed, the optional redundant Power Supply Module shares the power load with the main AC Power Supply Module. If one power supply fails, the remaining power supply assumes the role of providing all power to the Multichannel Media Converter, thereby protecting the Multichannel Media Converter from a system failure.

NOTE: Both the redundant Power Supply Module and the main AC Power Supply Module can be "hot swapped".

The **MAIN** power LED on the front panel of the Multichannel Media Converter LED is a steady amber when the AC Power Supply Module is operating properly. When the optional redundant Power Supply Module is installed and operating properly, the **BCKP** power LED is a steady green.

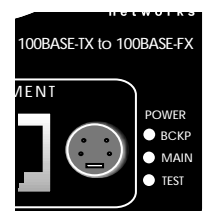

1.6 Multichannel Media Converter Management Module

TRANSITION Networks Multichannel Media Converters are shipped with a Management Module installed and functional. Embedded SNMP software in the Management Module allows network management of the Multichannel Media Converter.

Connections to Management Module

The network administrator can manage the Multichannel Media Converter using Management Module SNMP software accessed either through the PS/2 serial port or through the RJ-45 network port.

Management Module LEDs

A set of LEDs monitor the status of the Management Module.

LNK Steady LED indicates that a link has been established to the Management Module through the PS/2 serial port or through the RJ-45 network port.

REC Steady LED indicates that the Management Module is receiving traffic through the PS/2 serial port or through the RJ-45 network port.

Ready Steady LED indicates that the Management Module is properly installed and receiving power.

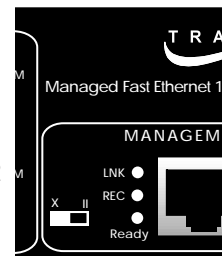

Serial Port

The network administrator can manage the Multichannel Media Converter through a command-line interface at a terminal or terminal emulator connected to the PS/2 port, through the supplied cable (PS/2 to DB9).

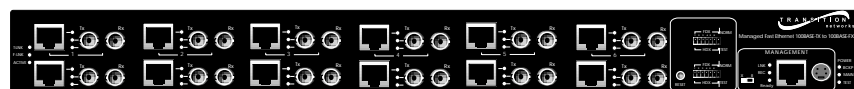

Attached terminal or terminal emulator connected to PS/2 serial port via management cable.



Network RJ-45 Connection

The RJ-45 Ethernet connection permits the network administrator to manage the Multichannel Media Converter using the TRANSITION Networks *Multiport Management Software* graphical interface (or other SNMP application) at a remote network management station (NMS). The RJ-45 Ethernet connection also permits the network administrator to use a remote Telnet connection to the Multichannel Media Converters.

The Multichannel Media Converters must be attached, through the RJ-45 Ethernet port, to a network that is accessible (via IP) from the computer at the remote location.

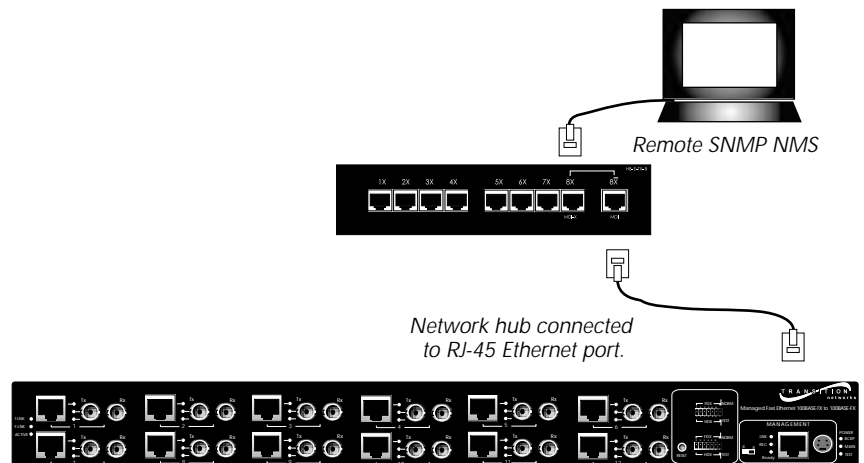

1.7 Multiport Management Software at Remote NMS

TRANSITION Networks *Multiport Management Software* allows remote management of the Multichannel Media Converter.

Clicking the **Help** button or the **?** button **at the Multiport Management Software screen** brings up links to an integrated set of **HELP** screens that provides direction for using the *Multiport Management Software* and that **CAN BE VIEWED AND PRINTED FROM ANY STANDARD HTML BROWSER.**

2 INSTALLATION

Direction for installing the TRANSITION Networks Multichannel Media Converter is provided in the pages that follow.

2.1	<i>Preparing the Site</i>	2.2
2.2	<i>Unpacking METTF10xx, MFETF10xx Equipment</i>	2.3
2.3	<i>Installing Optional Redundant Power Supply Module</i>	2.4
2.3.1	Setting Management Module Jumper	2.4
2.3.2	Installing Power Supply Module	2.5
2.4	<i>Installing Multichannel Media Converter at Site</i>	2.6
2.4.1	Standard Rack Installation	2.6
2.4.2	Table-Top Installation	2.7
2.5	<i>Powering the Multichannel Media Converter</i>	2.8
2.6	<i>Connecting Channel Ports to Network</i>	2.9
2.6.1	Setting FDX/HDX Channel Configuration Switches ..	2.9
2.6.2	Installing Fiber-optic Cable	2.10
2.6.3	Installing Twisted-Pair Copper Cable	2.11
2.7	<i>Setting Network Management Parameters</i>	2.12
2.8	<i>Connecting to TCP/IP Network Management at Remote Network Management Station (NMS)</i>	2.14
2.9	<i>Installing Multipport Management Software at Remote NMS</i>	2.15

2.1 Preparing the Site

Consider the following when choosing a site for the Multichannel Media Converter:

- Select a site that provides conditions that conform to the environmental requirements listed in the appendix.
- Select a site that is dust-free and moisture-free.
- Do not block the ventilation openings on the Multichannel Media Converter. The site should allow for proper heat dissipation from, and adequate ventilation around, the Multichannel Media Converter.
- Be sure that the site will allow easy access to twisted-pair cables, fiber-optic cables, and power cord(s).
- Use dedicated power circuits or power stabilizers to supply reliable power to the Multichannel Media Converter.
- Keep twisted-pair cabling away from sources of electrical noise, such as radios, electric motors, transmitters, broadband amplifiers, power lines, and fluorescent fixtures.

Also:

- ALL NODES connected to the ports on the media converter **must operate at the same speed**: 10 Mb/s or 100 Mb/s, according to Multichannel Media Converter model selected.
- The nodes connected to EACH CHANNEL on the Multichannel Media Converter **must operate in the same duplex mode**, either half-duplex or full-duplex. Do NOT, for instance, connect a node operating at half-duplex to a twisted-pair port and then connect another node operating at full-duplex to the fiber-optic port of the same channel.

2.2 Unpacking METTF10xx, MFETF10xx Equipment

Use the following list to verify the shipment:

Item

Multichannel Media Converter

Rack mounting kit

Four self-adhesive rubber feet

Power Cord

Management Control Cable

Multipoint Management Software Disk

Redundant Power Supply Module
(with Power Cord)

User's Guide

2.3 Installing Optional Redundant Power Supply Module

The standard Multichannel Media Converter is shipped with one **MAIN** Power Supply Module installed at the back of the Multichannel Media Converter cabinet and with a protective plate covering an installation slot intended for a second, optional **BACKUP** Power Supply Module.

NOTE: Prior to installation of the optional redundant Power Supply Module, a jumper setting on the Management Module already installed in the Multichannel Media Converter must be changed from the **NORMAL** position to the **B(a)CK(u)P** position.

WARNING: DO NOT CONNECT POWER SUPPLY MODULE TO EXTERNAL POWER BEFORE INSTALLING IN MULTICHANNEL MEDIA CONVERTER. FAILURE TO OBSERVE THIS WARNING COULD RESULT IN EQUIPMENT DAMAGE AND/OR PERSONAL INJURY OR DEATH.

CAUTION: Wear a grounding device and observe electrostatic discharge precautions when setting Management Module jumper and when installing Power Supply Module in Multichannel Media Converter. Failure to observe this caution could result in damage to, and subsequent failure of, Management Module and/or Power Supply Module.

NOTE: Power Supply Modules can be "hot swapped".

2.3.1 Setting Management Module Jumper

CAUTION: Failure to set the Management Module NJP1 jumper correctly may result in false alarms (if the jumper is set to BCKP while only one Power Supply Module is installed) or in failure to monitor the redundant power supply (if a second Power Supply Module is installed and the jumper is left in the NORMAL position).

To set the Management Module jumper:

1. Place the Multichannel Media Converter on a clean, stable surface.
2. Locate the Management Module installed at the back left of the Multichannel Media Converter.
3. Carefully remove the Management Module from the Multichannel Media Converter by unscrewing two (2) thumbscrews that secure the Management Module to the Multichannel Media Converter and then gently sliding the Management Module from the Multichannel Media Converter.
4. Place the Management Module on flat, stable surface and locate the jumper identified as NJP1.
5. Using a small needle-nosed pliers or similar device, change the 2-position jumper labelled NJP1 from the **NORMAL** position to the **BACKUP** position (indicated on Management Module circuit board).

6. Carefully slide the Management Module back into the Multichannel Media Converter.

Ensure that the frame of the Management Module runs smoothly between the guides at the bottom of the Multichannel Media Converter. Note a slight resistance just before the Management Module frame comes flush with the rear panel of the Multichannel Media Converter. At this point, ensure that the edges of the Management Module run parallel to the corresponding edges of the Multichannel Media Converter. Then, apply gentle pressure to seat the Management Module in the Multichannel Media Converter.

7. Secure the Management Module to the Multichannel Media Converter by tightening the two (2) thumbscrews.

2.3.2 Installing Power Supply Module

1. Locate the protective plate installed over the redundant Power Supply Module installation slot at the rear of the Multichannel Media Converter.
2. Remove the protective plate from the Multichannel Media Converter by unscrewing two (2) thumbscrews that secure the protective plate to the Multichannel Media Converter redundant Power Supply Module installation slot.

3. Carefully slide the Power Supply Module into the Multichannel Media Converter installation slot.

Ensure that the frame of the Power Supply Module runs smoothly between the guides at the bottom of the Multichannel Media Converter. Note a slight resistance just before the Power Supply Module frame comes flush with the rear panel of the Multichannel Media Converter. At this point, ensure that the edges of the Management Module run parallel to the corresponding edges of the Multichannel Media Converter. Then, apply gentle pressure to seat the Power Supply Module in the Multichannel Media Converter.

4. Secure the Power Supply Module to the Multichannel Media Converter by tightening the two (2) thumbscrews.

2.4 Installing Multichannel Media Converter at Site

The Multichannel Media Converter can be installed in a standard rack or on a table, shelf, or other stable surface.

2.4.1 Standard Rack Installation

NOTE: Installation bracket mounting screws are provided. Rackmount screws and clip nuts are NOT provided.

To install the Multichannel Media Converter in a standard rack:

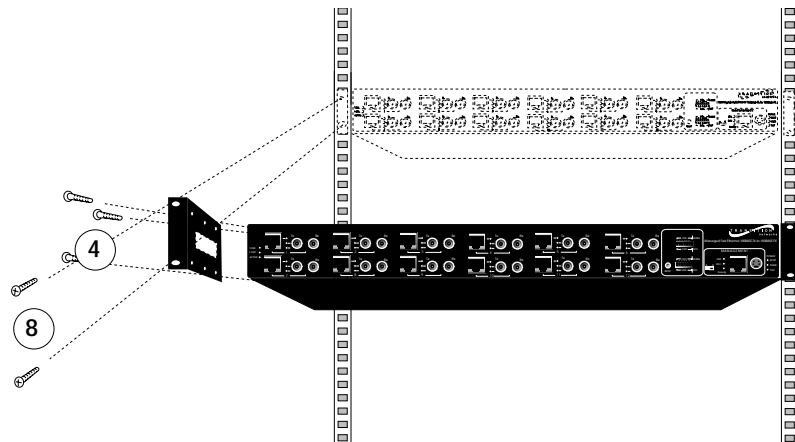

1. Locate six (6) installation bracket screws (*provided*) for each Multichannel Media Converter chassis to be installed.
WARNING: Mount Multichannel Media Converter chassis evenly and securely in rack. Failure to observe this warning could allow the Multichannel Media Converter to fall, resulting in equipment damage and/or possible injury to personnel.
2. Align universal mounting bracket in selected position against side of Multichannel Media Converter chassis so that chassis installation holes are visible through universal bracket installation holes.
3. Using Phillips screwdriver, install three (3) screws through mounting bracket into chassis installation holes on side of Multichannel Media Converter.
4. Repeat steps 3 and 4 for second mounting bracket.
5. Locate four (4) screws (*not provided*) and optional clip-nuts (*not provided*) for each Multichannel Media Converter to be installed.
6. Carefully align Multichannel Media Converter at secure and level position between the site rack mounting rails.
7. Install two (2) screws through right bracket into right mounting rail and two (2) screws through left bracket into left mounting rail, using clip nuts to secure if necessary.

2.4.2 Table-Top Installation

The Multichannel Media Converter is shipped with four (4) rubber feet for optional installation on table or other flat, stable surface.

CAUTION: Do not place the Multichannel Media Converter on active, heat generating equipment and avoid placing other devices on top of the Multichannel Media Converter. Failure to observe this caution could cause Multichannel Media Converter to fail.

1. Select a level, secure surface in a well-ventilated area.
2. Remove the adhesive protective sheet from the rubber feet (*provided*) and affix the feet to the corners on the bottom of the Multichannel Media Converter, approximately 1 centimeter from each edge.
3. Set the Multichannel Media Converter securely upright on the stable surface.

2.5 Powering the Multichannel Media Converter

NOTE: The Multichannel Media Converter does NOT have a power ON/OFF switch. Power is applied to, and removed from, the Multichannel Media Converter by connecting and disconnecting the power cord.

NOTE: The Main Power Supply Module and the Redundant (backup) Power Supply Module each has a separate power cord. Increase protection to the Multichannel Media Converter from operational failure due to power circuit failure by connecting the two power cords to outlets on separate power circuits.

To power the Multichannel Media Converter through the AC Power Supply Module(s):

1. Locate Power Supply Module(s) at back of Multichannel Media Converter.
2. Connect female end of power cord to power receptacle on Power Supply Module.
3. Plug male end of power cord into correct voltage AC rack or wall outlet.
4. If optional Redundant (backup) Power Supply Module is installed in Multichannel Media Converter, repeat steps 2 and 3 for second Power Supply Module.
4. Verify that Multichannel Media Converter is powered by observing illuminated LED(s) and noting operation of Power Supply Module fan(s).

2.6 Connecting Channel Ports to Network

Each channel port is connected, using twisted-pair copper and fiber-optic cable, to network devices.

2.6.1 Setting FDX/HDX Channel Configuration Switches

FDX/HDX (F(ull-)D(uple)X and H(alf)D(uple)X) refers to the manner in which a network device sends and receives data on the network. A network device that is operating in half-duplex mode either sends data or receives data, in turn. A network device that is operating in full-duplex mode both sends and receives data, simultaneously.

NOTE: The Multichannel Media Converter is an HDX/FDX auto-negotiating device which transmits "FDX Advertising" signals to attached network devices and forces FDX-capable network devices to FDX. *Though each channel of the Multichannel Media Converter can operate in either full-duplex or half-duplex mode, setting the entire network to full-duplex mode maximizes throughput and distances. To achieve this, ALL interconnected devices must be capable of full-duplex and properly set.*

CAUTION: If any network devices connected to a channel are not capable of full-duplex (FDX), then all other channel devices must be set to half-duplex (HDX), INCLUDING THE MULTICHANNEL MEDIA CONVERTER CHANNEL. Failure to observe this caution will result in excess network collisions.

NOTE: Each channel FDX/HDX switch must be set separately. Do NOT connect a node operating at half-duplex to a twisted-pair port and then connect another node operating at full-duplex to the fiber-optic port of the same channel. Do NOT connect a node operating at full-duplex to a twisted-pair port and then connect another node operating at half-duplex to the fiber-optic port of the same channel.

Setting Full-Duplex/Half-Duplex Configuration Switches

1. Locate six (6) FDX/HDX switches that are associated with six (6) copper-to-fiber media converter channels (DIP switches #1-6 at front of Multichannel Media Converter).
2. Referring to full-duplex/half-duplex mode of network devices to be attached to channel nodes, **FOR EACH CHANNEL**, set the associated configuration switch to FDX (full-duplex): UP or to HDX (half-duplex): DOWN.

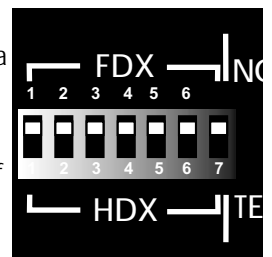

2.6.2 Installing Fiber-optic Cable

Refer to the appendix for cable specifications for the 10BASE-FL or the 100BASE-FX fiber-optic installation.

Installing Cable

1. Locate or build 10BASE-FL-compliant or 100BASE-FX-compliant cables (depending upon Multichannel Media Converter selected for the site), with male two-stranded TX to RX connectors installed at both ends.
2. Connect TX and RX connectors at one end of cable to mating Multichannel Media Converter TX and RX fiber-optic connector.
3. Connect cable with connector installed at TX location on Multichannel Media Converter channel to RX location on attached network device.

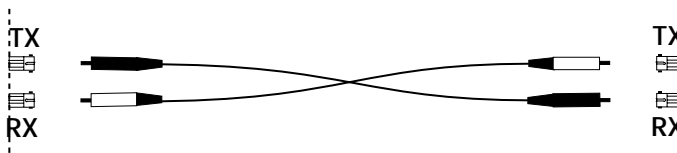

4. Connect cable with connector installed at RX location on Multichannel Media Converter channel to TX location on attached network device.

Testing Fiber Link(s)

NOTE: The Link Test switch (DIP switch #7) enables and disables the Link Test feature for a block of six (6) Multichannel Media Converter channels.

When the Link Test feature is enabled (set to NORMAL position), if the Multichannel Media Converter senses loss of a twisted-pair link, the associated fiber-optic link is cut. Then the remote device senses loss of the fiber-optic link and, if the remote device is another Multichannel Media Converter also set to NORMAL mode, the remote Multichannel Media Converter disables the twisted-pair port. Finally the remote device becomes aware that the link to the opposite end device connected to this channel is not fully functional and subsequently triggers a back-up mechanism (if so equipped) and/or alerts the network manager.

Thus, when the Link Test feature is enabled (set to NORMAL position), if a Multichannel Media Converter does not detect a good link on the twisted-pair 10BASE-T /100BASE-TX side of any channel, the Multichannel Media Converter disables all data transmission (including active-idle) on the fiber-optic 10BASE-FL/100BASE-FX side of that channel.

However, the network administrator facing a device with no link indication cannot tell whether that no link indication is due to the loss of the fiber-optic link or due to loss of the remote twisted-pair link.

Therefore, when installing a fiber-optic network, disable the Link Test feature (set to TEST position) to establish that the Multichannel Media Converter fiber-optic links are operational and THEN connect network devices through the twisted-pair links.

To perform a link test:

1. Verify that all network devices connected to the fiber-optic ports on the Multichannel Media Converter are powered ON and operational.
2. Cycle power to the Multichannel Media Converter by pressing the RESET button, if present, or by disconnecting the power cord from the external AC outlet and then reconnecting the power cord to the external AC outlet.

Verify that the Multichannel Media Converter is powered ON and is operational:

- Verify that the Multichannel Media Converter **MAIN LED** is a steady amber, indicating that the unit is receiving power.
- If an optional redundant power supply is installed, verify that the **BCKP LED** is a steady green.
- Verify that the power supply fan(s) is/are operational.

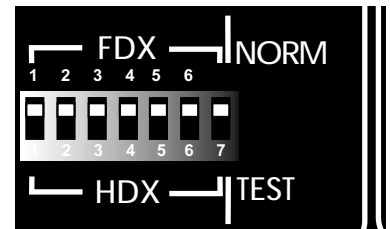

3. For each set of six (6) channels, set the Link Test switch (DIP switch #7) to the **TEST** position.
The **TEST LED(s)** at the front right panel should be amber.
4. Verify that the **F-LNK LED** for EACH Multichannel Media Converter fiber-optic port with installed fiber-optic cable is illuminated, indicating that a link exists between the fiber optic port on the Multichannel Media Converter and the network device connected to the channel port.
5. Return the Link Test switch (DIP switch #7) to the **NORMAL** position.

2.6.3 Installing Twisted-Pair Copper Cable

Refer to the appendix for cable specifications for the 10BASE-T or the 100BASE-TX twisted-pair copper installation.

Installing Cable

1. Locate or build 10BASE-T or 100BASE-TX-compliant cables (depending upon Multichannel Media Converter selected for the site) with male RJ-45 connectors installed at both ends.

NOTE: Use a straight-through cable to connect a hub or a switch to a twisted-pair channel port on the Multichannel Media Converter. Use a crossover cable to connect a workstation to a twisted-pair channel port on the Multichannel Media Converter.
2. Connect RJ-45 connector at one end of cable to Multichannel Media Converter RJ-45 twisted-pair channel port connector.
3. Connect RJ-45 connector at other end of cable to device RJ-45 port connector.

2.7 Setting Network Management Parameters

CAUTION: IP parameters should be set and/or modified **ONLY** at the attached terminal Interface.

To set the Multichannel Media Converter network parameters:

1. Locate a PC equipped with any terminal emulation program.
2. Connect the Multichannel Media Converter to the PC by connecting the miniDIN end of the control cable (*provided*) to the Multichannel Media Converter Management PS/2 port and the other end of the cable to the PC DB-9 serial port connector.

NOTE: By default, the Multichannel Media Converter uses the following serial port parameter values:

bits per second	9600
stop bits	1
data bits	8
parity	NONE
flow control	Xon/Xoff

3. Using methods appropriate to the attached terminal, verify that the serial port parameters of the attached terminal match the Multichannel Media Converter port parameter values. If necessary, modify the attached terminal port parameter values.
4. Start the terminal emulation program.
5. Cycle power to the Multichannel Media Converter by disconnecting the power cord from the external AC outlet and then reconnecting the power cord to the external AC outlet..

After a few seconds the start up screen comes up.

Management card configuration

NETWORK PARAMETERS:

IP address on LAN is 192.168.1.99
CONSOLE PARAMETERS:

console channel will use a baud rate of 9600
BOARD PARAMETERS:

Processor : MPC850, Running at 50Mhz
Board Info : Management Board
Board memory : FLASH : 4Mbytes
SDRAM : 4Mbytes
Board's Ethernet hardware address :
0:A0:D2:2F:80:82

To change any of this, press any key within 5 seconds

6. Immediately press any key in order to access the configuration procedure. Type 'm' (or 'M') to modify the current settings.

The software then prompts with a series of default parameter values in braces and a prompt either to press the 'Return' key to keep a displayed parameter or to enter a new value.

```
(M)odify any of this or (C)ontinue? [M] m
For each of the following questions, you can press
<Return> to select the value shown in braces, or you
can enter a new value.
NETWORK PARAMETERS:
-----
Do you want a LAN interface? [Y]
This board's LAN IP address(0.0.0.0 = RARP)?
[192.168.1.99]
Use a subnet mask for the LAN interface? [N] y
Subnet mask for LAN (0 for none)? [0.0.0.0]
Should there be a default gateway for packet routing?
[N] y
What is its IP address? [0.0.0.0]
CONSOLE PARAMETERS:
-----
Baud rate for serial channels [9600]
ETHERNET PARAMETERS:
-----
Do you want to change the board's Ethernet address?
[N] y
Byte 0 must be 00
  What should byte 1 be? [A0]
  What should byte 2 be? [D2]
  What should byte 3 be? [2F]
  What should byte 4 be? [80]
  What should byte 5 be? [82]
SNMP PARAMETERS:
-----
Get community [public]
Set community [private]
Trap destination [192.168.1.15]
Trap community [trap]
System name [LAN]
System location [location]
System Contact [administrator]
How long (in seconds) should CPU delay before
starting up? [5]
```

NOTE: Changing the CPU delay value above from **5** to **15** makes it easier to continue again later.

When configuration is complete, the startup screen comes up with the new parameters.

To continue modifying the configuration parameters, again type 'm' to modify.

7. Type 'c' to save the configuration, initialize the system, and continue:

```
Updating parameter storage. This may take a
while...Done
Initialization...
```

8. Observe the illuminated **Ready** Multichannel Media Converter Management LED.

NOTE: The Multichannel Media Converter can be managed at the terminal emulation interface. See Section 3 OPERATION.

2.8 Connecting to TCP/IP Network Management at Remote Network Management Station (NMS)

It is recommended that the Multichannel Media Converter RJ-45 MANAGEMENT port be connected to the TCP/IP network management station (NMS) through a switch or a hub that also is connected to other managed network devices. If the Multichannel Media Converter RJ-45 MANAGEMENT port is connected directly to the NMS, the NMS will manage only that Multichannel Media Converter.

1. Locate or build a 10BASE-T-compliant twisted-pair shielded cable with RJ-45 plug connectors installed at both ends.

NOTE: Straight-through or crossover cable can be used, since the Multichannel Media Converter provides either an RJ-45 10BASE-T Ethernet port with an associated MDI-II/MDI-X switch or two RJ-45 10BASE-T ports, one configured as straight-through and the other configured as crossover, for connecting the Multichannel Media Converter to TCP/IP network management.

2. Connect RJ-45 connector at one end of cable to Multichannel Media Converter RJ-45 twisted-pair Management port.
3. Connect RJ-45 connector at other end of cable to RJ-45 port on 10BASE-T-compliant hub or switch.
4. Verify that the Multichannel Media Converter MANAGEMENT **L(i)NK** LED is illuminated. If not, change the MDI-II/MDI-X switch setting or the position of the RJ-45 shielded cable connection.
5. Verify that the appropriate LINK indicator on the hub or switch is illuminated.

NOTE: If installing *Multiport Management Software* at the NMS, skip the following steps and proceed to the next section.

6. Referring to documentation that comes with the NMS management application, copy the MIB file (SUPPLIED - located on the *Multiport Management Software* to the default NMS management application directory.
7. Again referring to documentation that comes with the NMS management application, add the new MIB to the NMS management application list and recompile the MIBs.

2.9 Installing Multipoint Management Software at Remote NMS

NOTE: Multipoint Management Software 1.0 runs on a variety of platforms. On most Win32 platforms, Multipoint Management Software 1.0 can be used as "standalone" or as an integrated component with HP Open View. Using HP Open View on HP UX Unix and Solaris, Multipoint Management Software runs only as an integrated component ; there is no "standalone" Unix version of this software.*

To install the TRANSITION Networks *Multipoint Management Software* graphical interface at a remote network management station (NMS):

1. Ensure that the Multichannel Media Converter is attached, through the 10BASE-T port, to a TCP/IP network that is accessible (via IP) from the network management station.

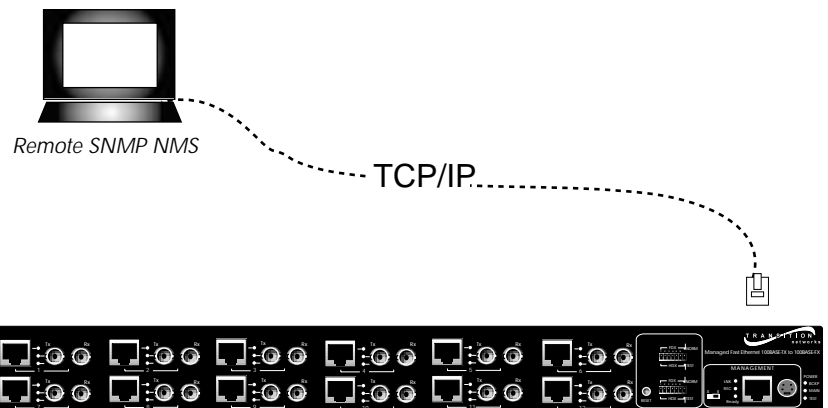

2. At the network management station, load the *Multipoint Management Software* from the Multipoint Management Software Disk:

Win32 Systems

Run **Setup.exe** (located in the \TransitionNetworks\win directory).

Unix Systems

Run **install.sh** (located in the /TransitionNetworks/unix directory).

*Microsoft Windows 95, 98, ME, NT 4.0, Windows 2000

3. OPERATION

Daily operation of the TRANSITION Networks METTF10xx, MFETF10xx Multichannel Media Converter requires no network administrator activity except the occasional monitoring of status LED indicators at the front of the Multichannel Media Converter.

Optionally, the network administrator can monitor and manage the Multichannel Media Converter using an attached terminal or terminal emulator or at a remote Telnet connection. The network administrator also can monitor and manage the Multichannel Media Converter using an SNMP application such as TRANSITION Networks *Multiport Management Software* at a remote Network Management Station (NMS).

Direction is provided in the pages that follow:

3.1	<i>Using Status LEDs</i>	3.2
3.2	<i>Using a Terminal Emulator</i>	3.3
3.3	<i>Using Multiport Management Software at Remote NMS</i>	3.6

3.1 Using Status LEDs

Status LEDs monitor *Multichannel Media Converter* operation.

Power Supply and Link Test Switch LEDs

LED	Color	Indicates
MAIN	Amber	The main power supply is functional.
	<i>Weak/flashing Amber</i>	The main power supply is failing or failed.
BCKP	Green	The optional redundant power supply, if installed, is functioning normally.
	<i>Weak/flashing Green</i>	The optional redundant power supply, if installed, is failing or failed.
NORM	Steady Green	The unit is NOT performing a Link Test.
TEST	Steady Amber	The unit is performing a Link Test on the fiber-optic ports.



Management LEDs

LED	Color	Indicates
LNK	Steady Green	A link is established between the Management Module and the connected network device.
REC	Flashing Green	The Management Module is receiving data.
Ready	Steady	The Management Module is installed and functioning normally.

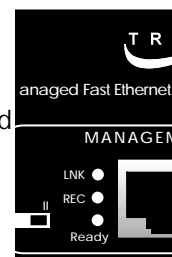

Channel LEDs

LED	Color	Indicates
T-LNK	Steady Green	A link is established between the twisted-pair port and the connected network device.
F-LNK	Steady Green	A link is established between the fiber-optic port and the connected network device.
ACTIVE	Flashing Amber	The fiber-optic port is receiving data.

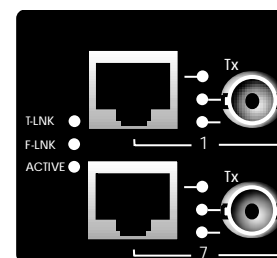

3.2 Using a Terminal Emulator

The Multichannel Media Converter Management Module terminal emulator interface permits the network administrator to display status messages and to display and to modify selected network settings.

CAUTION: IP parameters can be set and/or modified ONLY at the attached terminal Interface.

The Multichannel Media Converter command-line interface is accessible using a terminal or terminal emulator attached to the PS/2 serial port on the Multichannel Media Converter.

NOTE: The serial port cable is attached directly to a DTE device through the serial port management control cable shipped with the Multichannel Media Converter.

1. Locate a PC equipped with any terminal emulation program.
2. Connect the Multichannel Media Converter to the PC by connecting the miniDIN end of the control cable (*provided*) to the Multichannel Media Converter Management PS/2 port and the other end of the cable to the PC DB-9 serial port connector.

NOTE: By default, the Multichannel Media Converter uses the following serial port parameter values:

bits per second	9600
stop bits	1
data bits	8
parity	NONE
flow control	Xon/Xoff

3. Using methods appropriate to the attached terminal, verify that the serial port parameters of the attached terminal match the Multichannel Media Converter port parameter values. If necessary, modify the attached terminal port parameter values.
4. Start the terminal emulation program.
5. Cycle power to the Multichannel Media Converter by disconnecting the power cord from the external AC outlet and then reconnecting the power cord to the external AC outlet...

After system initialization, a banner display comes up.

```
*****
* Software version: v2.0.4T *
* Version date: 25/02/01 *
* Vendor: Transitiob Networks *
* Model: MFETF1013-120 *
*****
```

Using Terminal Emulator

Thrn the **main menu** comes up with the following options:

1. Device status
2. Device control
3. File download (TFTP)

Select (1-3):

NOTE: The TFTP feature is NOT enabled in the current software version.

At the **main menu**, select **1** to display the **device (port(s)) status menu**, which shows the status of each Multichannel Media Converter channel (including twisted-pair and fiber-optic link status, test state, and duplex mode), as well as the status of the power supplies and the chassis temperature.

Port(s) status:

```
=====
```

Channel	TP Link	FO Link	Test	FDX
01	OFF	OFF	OFF	ON
02	OFF	OFF	OFF	ON
03	OFF	OFF	OFF	ON
04	OFF	OFF	OFF	ON
05	OFF	OFF	OFF	ON
06	OFF	OFF	OFF	ON
07	OFF	OFF	OFF	ON
08	OFF	OFF	OFF	ON
09	OFF	OFF	OFF	ON
10	OFF	OFF	OFF	
11	OFF	OFF	OFF	ON
12	OFF	OFF	OFF	ON

Main Power supply : OK

Backup Power supply : NOT INSTALLED

Temperature: 35

Press <CR> to continue...

Return to the **main menu** by pressing <return>.

At the **main menu**, select option **2** to display the **device control menu**, which allows the network administrator to reset the Multichannel Media Converter cards, to change test mode, and to enter the duplex mode change menu.

Device control:

=====

1. Reset bottom card.
2. Change bottom test.
3. Reset top card.
4. Change top test.
5. Change HDX commands.
0. Main menu.

Select (0-5):

NOTE: Options 3 and 4 do not appear in Multichannel Media Converters with only six channels.

Return to the **main menu** by selecting 0.

At the **device control menu**, select option **5** to display the **HDX control menu**. At the **HDX control menu**, toggle selected channels between half-duplex mode and full-duplex mode. Selecting one of the numbered options at the **HDX control menu** changes the duplex mode of the associated channel: Selecting **5** toggles the duplex mode of channel 5.

HDX control:

=====

1. Change CH1 - FDX/HDX.
2. Change CH2 - FDX/HDX.
3. Change CH3 - FDX/HDX.
4. Change CH4 - FDX/HDX.
5. Change CH5 - FDX/HDX.
6. Change CH6 - FDX/HDX.
7. Change CH7 - FDX/HDX.
8. Change CH8 - FDX/HDX.
9. Change CH9 - FDX/HDX.
10. Change CH10 - FDX/HDX.
11. Change CH11 - FDX/HDX.
12. Change CH12 - FDX/HDX.
0. Device control menu.

Select (0-12):

NOTE: Options 7-12 do not appear in Multichannel Media Converters with only six channels.

View the change in the device status listing (accessible from the **main menu**). Return to the **device control menu** by selecting 0.

3.3 Using Multiport Management Software at Remote NMS

The LED indicators available on the physical METTF10xx or MFETF10xx Multichannel Media Converter also can be displayed graphically at a remote network management station (NMS), using installed TRANSITION Networks *Multiport Management Software*.

The *Multiport Management Software* brings up a drawing that represents each selected managed METTF10xx or MFETF10xx Multichannel Media Converter, identified by IP address. "LED indicators" represent physical LEDs on physical METTF10xx or MFETF10xx devices. The "LEDs" are "illuminated" to indicate the state of the METTF10xx or MFETF10xx at the time of the last *Multiport Management Software* polling.

In addition, METTF10xx or MFETF10xx Multichannel Media Converter status information is available in text format.

To bring up the *Multiport Management Software* graphical display for a selected METTF10xx or MFETF10xx Multichannel Media Converter:

Standalone Win32* Systems

1. At the remote NMS, access the **MULTIPOINT MANAGEMENT SOFTWARE ICON** from the **START** menu within the **TRANSITION** options in the **PROGRAMS** menu.

The Multiport Management Software comes up and then prompts for the IP address of the METTF10xx or MFETF10xx Multichannel Media Converter to be managed.

2. Enter the IP address of the manageable METTF10xx or MFETF10xx Multichannel Media Converter.

A graphical representation of the selected METTF10xx or MFETF10xx Multichannel Media Converter comes up, with the node IP address displayed in the upper left corner of the screen.

System HP Open View

1. At the remote NMS, from the **GRAPHICAL USER INTERFACE**, select the **TRANSITION** icon.
2. Select the **TOOLS** icon from the menu bar and scroll down to select the **MULTIPOINT MANAGER** option.
3. Scroll down to select the node (IP address) of the manageable METTF10xx or MFETF10xx Multichannel Media Converter.

A graphical representation of the selected METTF10xx or MFETF10xx Multichannel Media Converter comes up, with the node IP address displayed in the upper left corner of the screen.

*Microsoft Windows 95, 98, ME, NT 4.0, Windows 2000

CAUTION: Do NOT make IP configuration changes from the Multiport Management Software text-format displays. Make IP configuration changes ONLY through the serial port command-line interface. (See Section 2. Installation.) Failure to observe this caution could result in unanticipated configuration faults and failures.

NOTE: Click the **Help** button OR the **?** button **on any screen** to bring up links to an integrated set of **HELP** screens that CAN BE VIEWED AND PRINTED FROM ANY STANDARD HTML BROWSER:

The following conventions are used at the *Multiport Management Software* graphical interface:

TP* Link, Fiber Link, TP* Activity, and Fiber Activity are either green for *up/detected* or dim gray for *down/not detected*.

Full Duplex Mode (Fast Ethernet devices only) is green when running in *Full-Duplex Mode* and dim gray when running in *Half-Duplex Mode*. To change Duplex Mode (only on Fast Ethernet devices), click on the button labeled: **Toggle Duplex Mode** and wait. (Several polling cycles may be required for the application to "recognize" the change.)

Main Power Supply Status is green for *OK* or red for *fail*.

Backup Power Supply Status is green for *OK*, red for *fail*, or dim gray for *not installed*.

Temperature provides the inside temperature of the device in degrees Celsius.

Poll Rate is the time interval, in seconds, that the application polls the managed device. To change the **Poll Rate**, enter a new integer value and press the "Enter" key.

System up Time is the time in days, hours, minutes, and seconds since the last power-cycle (reboot) of the managed device.

Refresh issues a "get request" on all data associated with the open screen. (Same as a poll.)

MIB2sysName field is a read/write field for the system name. To change the system name entry, type a new entry in the **MIB2sysName** field and press the "enter" key. Changes appear at the next polling interval.

MIB2sysLocation is a read/write field for the system location. To change the system location entry, type a new entry in the **MIB2sysLocation** field and press the "enter" key. Changes appear at the next polling interval.

MIB2sysContact is a read/write field for the system administrator contact. To change the system administrator contact entry, type a new entry in the **MIB2sysContact** field and press the "enter" key. Changes appear at the next polling interval.

MIB2sysDescription is a read-only field for the system description.

*twisted-pair

4 MAINTENANCE

Maintenance direction for the TRANSITION Networks Multichannel Media Converter provided in this section includes:

- 4.1 *Fault Isolation and Recovery*4.2**
- 4.2 *Hardware Replacement Procedures*4.5**
 - 4.2.1 Replacing Management Module4.5
 - 4.2.2 Replacing AC Power Supply Module4.6

4.1 Fault Isolation and Recovery

Determine the answers to the following questions and, where appropriate, take the indicated action(s):

1. ***Does Multichannel Media Converter Reset Correct the Condition?***

- Press the RESET button at the front of the Multichannel Media Converter Management Module for about one (1) second.

The LEDs at the front of the Multichannel Media Converter should flash once, then the Multichannel Media Converter should return to normal network operation.

- Observe the results.

2. ***Is Multichannel Media Converter Receiving Power?***

- Inspect power LED indicators at the front of the Multichannel Media Converter.

If the MAIN LED is OFF:

- Ensure that the power cord for the MAIN power supply is connected securely to the Multichannel Media Converter MAIN power supply and to the power outlet.
- Ensure that the MAIN power supply module is seated firmly in the Multichannel Media Converter.
- Ensure that the MAIN power supply module power outlet has power and that the AC input power source is between 100VAC and 240VAC.
- Contact TRANSITION Networks Technical Support.

If an optional redundant power supply is installed but the BCKP LED is OFF:

- Ensure that the power cord for the redundant power supply is connected securely to the Multichannel Media Converter redundant power supply and to the power outlet.
- Ensure that the redundant power supply module is seated firmly in the Multichannel Media Converter.
- Ensure that the redundant power supply module power outlet has power and that the AC input power source is between 100VAC and 240VAC.
- Contact TRANSITION Networks Technical Support.

3. **Are Channel Links Good?**

If the T-LNK LED for a twisted pair port is OFF:

- Ensure the network device connected to the twisted-pair channel port is powered ON.
- Ensure that the twisted-pair cable is connected securely both to the channel port and to the network device.
- If the network device connected to the port is a workstation, ensure that the cable is in the crossover configuration.
- If the network device connected to the port is a hub or switch, ensure that the cable is in the straight-through configuration.
- Ensure that the network device connected to the port is operating at correct speed: 10 Mb/s or 100 Mb/s.

If the F-LNK LED for a fiber optic port is OFF:

- Ensure that the network device connected properly to the fiber-optic port is powered ON.
- Ensure that the fiber-optic cable is connected to the fiber-optic port and to the network device.
- Ensure that the network device connected to the fiber-optic port is operating at correct speed: 10 Mb/s or 100 Mb/s.
- Set the Link Test switch(es) to TEST position (to isolate fiber link faults from faults on the twisted-pair network).

Allow 5-10 seconds for all devices to link-up. All LNK LEDs should be illuminated

NOTE! Remember to reset Link Test switch(es) to NORMAL after procedure is completed

- **Verify that the maximum allowable loss budget on the fiber-optic cable is within acceptable limits.**

If a LINK LED of a port is illuminated but there is a communication problem with the port:

- **Ensure that the duplex setting is set the same on the nodes connected to the twisted-pair and to the fiber-optic ports of the media converter channel.**

If all LNK LEDs are OFF but all network devices and fiber-optic cable are connected, a link-up problem is suspected:

- **Contact TRANSITION Networks Technical Support.**

4. **Is Management Connection Good?**

If the Management READY LED is OFF:

- Ensure that the Management Module is seated firmly in the Multichannel Media Converter.
- Ensure that the Management Module is configured properly (See Section 3 INSTALLATION).

If the configuration menu isn't readable or doesn't appear at all:

- Ensure that the serial cable is good.
- Ensure that the terminal settings are good.

If there is no SNMP response from the manager:

- Check the IP address on the configuration menu.
- Try to use the "ping" command.

If there is no "ping"

- Check the Ethernet cable.
- Check the LNK LED.

If there are no traps:

- Check the SNMP manager IP address in the trap destination on the configuration menu.

If the Multichannel Media Converter doesn't appear in the MIB browser:

- Ensure that the Multichannel Media Converter MIB file is copied to the proper location in the remote Network Management Station.
- Ensure that the MIBs are compiled with the new file.

4. **Is the Management Module connected to an active 10BASE-T Ethernet port?**

- Ensure that the Management LNK LED indicator is illuminated, indicating a good link.
- Ensure that the Management REC LED indicator is blinking, indicating that the Management Module is receiving data.

Failure may indicate that Multichannel Media Converter Management Module connection to the network has failed.

- Verify the integrity of the 10BASE-T hub/switch port to which the Multichannel Media Converter is attached.
- Verify the integrity of the 10BASE-T twisted-pair Ethernet cable that leads from the hub/switch to the Multichannel Media Converter.
- Contact TRANSITION Networks Technical Support.

4.2 Hardware Replacement Procedures

WARNING: The METTF10xx, MFETF10xx series Multichannel Media Converter contains no user-serviceable parts. **DO NOT, UNDER ANY CIRCUMSTANCES,** open and attempt to repair Multichannel Media Converter equipment. Failure to observe this warning could result in personal injury and/or death from electrical shock.

NOTE: Failure to observe the above warning will immediately void any warranty.

4.2.1 Replacing Management Module

CAUTION: Wear a grounding device and observe electrostatic discharge precautions when replacing Management Module in the Multichannel Media Converter. Failure to observe this caution could result in damage to, and subsequent failure of, the Management Module.

To replace the Management Module:

1. If the Multichannel Media Converter is powered, disconnect ALL power cables from AC wall outlet.
2. Locate Management Module to be replaced at the rear of the Multichannel Media Converter.
3. Carefully remove the Management Module to be replaced from the Multichannel Media Converter by unscrewing two (2) thumbscrews that secure the Management Module to the Multichannel Media Converter and gently sliding the Management Module from the Multichannel Media Converter.
4. Carefully slide the replacement Management Module into the Multichannel Media Converter.

Ensure that the frame of the Management Module runs smoothly between the guides at the bottom of the Multichannel Media Converter. Note a slight resistance just before the Management Module frame comes flush with the rear panel of the Multichannel Media Converter. At this point, ensure that the edges of the Management Module run parallel to the corresponding edges of the Multichannel Media Converter. Then, apply gentle pressure to seat the Management Module in the Multichannel Media Converter.

5. Tighten the two (2) thumbscrews that secure the replacement Management Module to the Multichannel Media Converter.

4.2.2 Replacing AC Power Supply Module

WARNING: DO NOT CONNECT POWER SUPPLY MODULE TO AC POWER BEFORE INSTALLING IN MULTICHANNEL MEDIA CONVERTER. FAILURE TO OBSERVE THIS CAUTION COULD RESULT IN EQUIPMENT DAMAGE AND/OR PERSONAL INJURY OR DEATH.

CAUTION: Wear a grounding device and observe electrostatic discharge precautions when replacing Power Supply Module in the Multichannel Media Converter. Failure to observe this caution could result in damage to, and subsequent failure of, the Power Supply Module.

To replace a Power Supply Module in the METTF10xx, MFETF10xx Multichannel Media Converter:

1. Locate Power Supply Module to be replaced at the rear of the Multichannel Media Converter.
2. Disconnect ALL power cables from AC wall outlet.
3. *At Multichannel Media Converter back*, disconnect power cord from power receptacle of Power Supply Module to be replaced.
4. Remove the Power Supply Module to be replaced from the Multichannel Media Converter by unscrewing two (2) thumbscrews that secure the Power Supply Module to be replaced to the Multichannel Media Converter.
5. Carefully slide the replacement Power Supply Module into the Multichannel Media Converter installation slot.

Ensure that the frame of the Power Supply Module runs smoothly between the guides at the bottom of the Multichannel Media Converter. Note a slight resistance just before the Power Supply Module frame comes flush with the rear panel of the Multichannel Media Converter. At this point, ensure that the edges of the Management Module run parallel to the corresponding edges of the Multichannel Media Converter. Then, apply gentle pressure to seat the Power Supply Module in the Multichannel Media Converter.

6. Secure the Power Supply Module to the Multichannel Media Converter by tightening the two (2) thumbscrews.
7. Connect female end of power cord to power receptacle on Power Supply Module.
8. Plug male end of power cord into correct voltage AC rack or wall socket.
9. Verify that Multichannel Media Converter is powered by observing illuminated Power LED and fan operation.

TECHNICAL SPECIFICATIONS

Dimensions

44.1 cm wide x 26.5 cm deep x 4.4 cm high (17.3" wide x 10.4" deep x 1.75" high)

Weight

4.2 kg (9.2 lbs)

Power

Input Supply Voltage

110-120/200-240 VAC DC, 50 to 60 Hz

Power Consumption



METTF10xx	35 Watts maximum
MFETF10xx	40 Watts maximum

Environment

Temperature:	0-40°C (32° to 104° F)
Storage Temperature:	-30 to 65°C (-22° to 149° F)
Humidity	10-90%, non condensing
Altitude	0-10,000 feet

Warranty

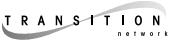
Lifetime

	DECLARATION OF CONFORMITY
Name of Mfg:	Transition Networks 6475 City West Parkway, Minneapolis MN 55344 USA
Model:	Multichannel Media Converter
Part Number:	MFETF1011-120, MFETF1013-120, MFETF1011-060, MFETF1013-060, METTF1011-120, METTF1013-120, METTF1011-060, METTF1013-060
Regulation:	EMC Directive 89/336/EEC
Purpose:	To declare that the Multichannel Media Converter to which this declaration refers is in conformity with the following standards. EMC-CISPR 22: 1985 Class A&B; EN 55022: 1988 Class A&B; EN 50082-1:1992; EN 60950 A4:1997; IEC 801.2, IEC 801.3, and IEC 801.4; IEC 950
<i>I, the undersigned, hereby declare that the equipment specified above conforms to the above Directive(s) and Standard(s).</i>	
 Stephen Anderson, Vice-President of Engineering	March 14, 2001 Date

CHANNEL CABLE SPECIFICATIONS

The physical characteristics of the media cable must meet or exceed IEEE 802.3 specifications.

Fiber-Optic Cable

Multimode:	62.5 / 125 μ m multimode fiber
	Optional:
	100 / 140 μ m multimode fiber
	85 / 125 μ m multimode fiber
	50 / 125 μ m multimode fiber
Singlemode:	9 μ m singlemode fiber

Twisted-Pair Copper Cable

Use shielded twisted-pair (STP) or unshielded twisted-pair (UTP) copper cable.

Category 3

Gauge	24 to 22 AWG
Attenuation	28 dB/1000' @ 10 MHz
Differential Characteristic Impedance	100 Ω \pm 10% @ 10 MHz

Category 5

Gauge	24 to 22 AWG
Attenuation	20 dB/1000' @ 10 MHz 22.0 dB /100m @ 100 MHz
Differential Characteristic Impedance	100 Ω \pm 10% @ 10 MHz

NOTE: The active pairs are pins 1 & 2 and pins 3 & 6. Use only dedicated wire pairs (such as blue/white & white/blue, orange/white & white/orange)

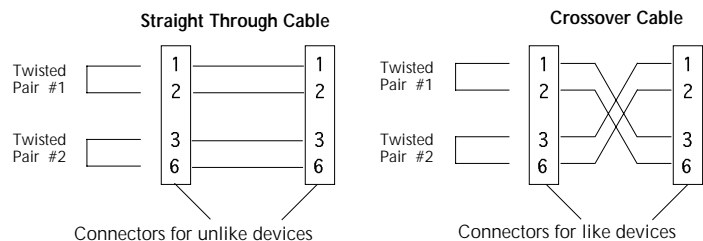

for the active pins.

When connecting the Multichannel Media Converter twisted-pair copper channel to a hub, switch, or router, use the **straight-through** cable configuration.

When connecting the Multichannel Media Converter twisted-pair copper channel to a terminal device such as a workstation or printer, use the **crossover** cable configuration.

METTF1011 (-120 and -060)

Channel Speed	10 Mb/s
Fiber-Optic Ports	
Cable:	Multimode fiber-optic
Connector Type	ST
Wavelength	850 nm
Transmitter Power	-15 dBm
Receiver Sensitivity	-32 dBm
Maximum Loss Budget	18 dB
Maximum distance	3 km (1.8 mi) <i>full-duplex</i>
Twisted-Pair Copper Ports	
Cable	Category 3 (or better) copper
Connector Type	RJ-45
Maximum distance	100 meters (328 feet)

METTF1013 (-120 and -060)

Channel Speed	10 Mb/s
Fiber-Optic Ports	
Cable:	Multimode fiber-optic
Connector Type	SC
Wavelength	850 nm
Transmitter Power	-15 dBm
Receiver Sensitivity	-32 dBm
Maximum Loss Budget	18 dB
Maximum distance	3 km (1.8 mi) <i>full-duplex</i>
Twisted-Pair Copper Ports	
Cable	Category 3 (or better) copper
Connector Type	RJ-45
Maximum distance	100 meters (328 feet)

MFETF1011 (-120 and -060)

Channel Speed	100 Mb/s
Fiber-Optic Ports	
Cable:	Multimode fiber-optic
Connector Type	ST
Wavelength	1300 nm
Transmitter Power	-20 dBm
Receiver Sensitivity	-30 dBm
Maximum Loss Budget	18 dB
Maximum distance	2 km (1.2 mi) <i>full-duplex</i>
Twisted-Pair Copper Ports	
Cable	Category 5 (or better) copper
Connector Type	RJ-45
Maximum distance	100 meters (328 feet)

MFETF1013 (-120 and -060)

Channel Speed	100 Mb/s
Fiber-Optic Ports	
Cable:	Multimode fiber-optic
Connector Type	SC
Wavelength	1300 nm
Transmitter Power	-20 dBm
Receiver Sensitivity	-30 dBm
Maximum Loss Budget	18 dB
Maximum distance	100 meters (328 feet) <i>full-duplex</i>
Twisted-Pair Copper Ports	
Cable	Category 5 (or better) copper
Connector Type	RJ-45
Maximum distance	100 meters (328 feet)

